

Bench Cupboard 300

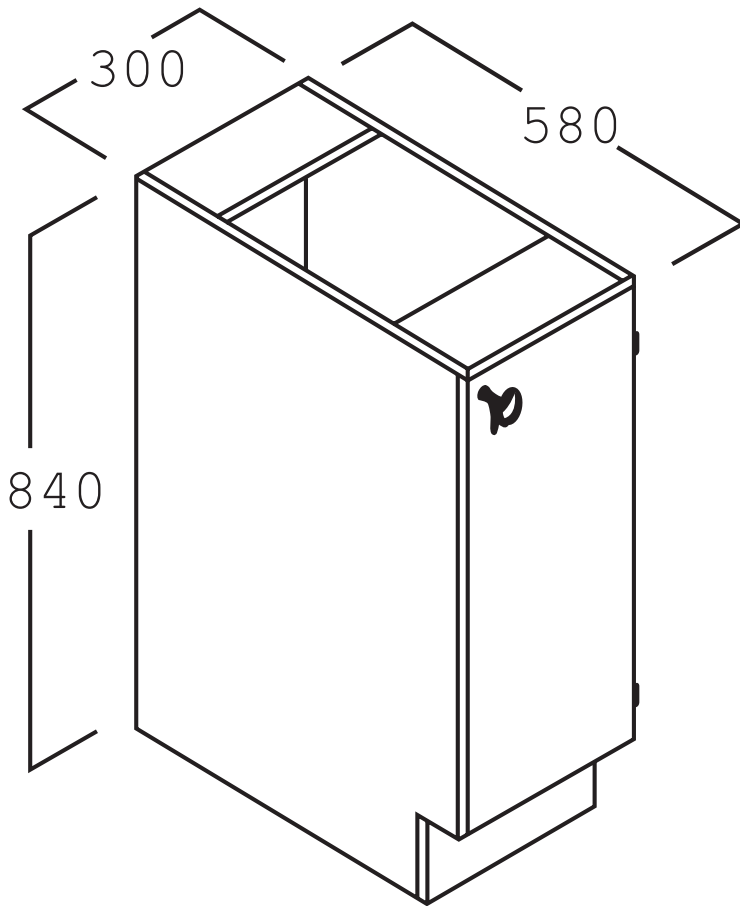

Name: Bench Cupboard 300

Description: Bench Cupboard 300 with 1 Door (Lockable) and no benchtop. Built by Batger to NSW DET standards.

Code: REB27

Size: 300W x 580D x 840H

Composition: 18mm Laminex E0 board
Adjustable feet for levelling (Internal)
1 Shelf
Lock

Options: Benchtop
LH or RH Door
Colour
Handles
Castors



Colours



Handles



More colours available in the **Laminex Commercial Range** brochure on our website.

* Default unless specified

